



ENMED® ENM - 432 Disposable Boot Covers

The ENMED ENM - 432 Disposable Boot Covers are featuring a white, laminated, low-linting fabric which is also designed to help protect the wearer's footwear from non-hazardous liquid splashes and dusts and may also help reduce contamination of the working environment.

Key Features

- Low lint.
- Latex free.
- Fluid repellent.
- Elastication at the top of the boot
- Boots feature ties made from the same laminated fabric as the Boot Covers

Applications

Catering
Electronics Manufacturing
Laboratories
Cleanrooms

This product is sold as an accessory and is not certified under the Personal Protective Equipment (PPE) Directive. A risk assessment should be carried out by a trained safety professional to ensure that appropriate PPE and accessories are selected and worn correctly. For more information, please contact ENMED.

Materials

Fabric: Polypropylene with a Polyethylene laminate

Fabric Weight: 55 GSM

Elastic: Neoprene Rubber

Tie: Polypropylene with Polyethylene laminate

Thread: Polyester / Cotton

Color: White

This product does not contain components made from natural rubber latex.

Sizing - Universal

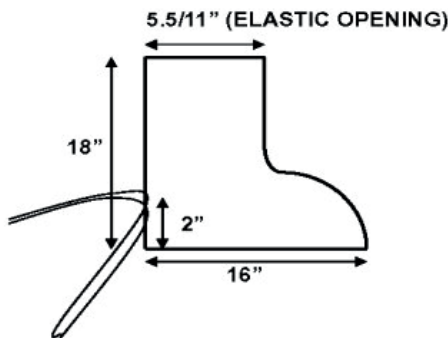







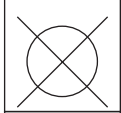

Ties on boots measure 50cm long x 0.5cm wide

Storage and Disposal

- Store in dry, clean conditions in original packaging, away from direct sunlight, sources of high temperature, and solvent vapours
- Store within the temperature range -5°C to +25°C and with relative humidity below 80%
- Expected shelf life is three years from date of manufacture when stored as stated
- Replace garments if damaged, heavily contaminated or in accordance with local work practice or regulations
- Handle and dispose of contaminated garments with care and in accordance with applicable regulations.

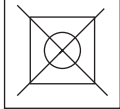
Limited Use

	DO NOT RE USE		DO NOT BLEACH		DO NOT IRON
	DO NOT DRY CLEAN		FLAMMABLE KEEP AWAY FROM SPARKS OF FLAMES		CONSULT INSTRUCTIONS FOR USE
	DO NOT WASH LAUNDERING IMPACTS UPON PROTECTIVE PERFORMANCE		DO NOT MACHINE DRY		CAUTION

Warnings and Limitations

Before use read and understand all user instructions and be sure that the product is suitable for the application and fitted correctly. Product must never be altered or modified. Prior to use inspect the clothing for any damage that could affect its protective function. Replace any damaged clothing. Care should be taken when removing contaminated garments, so as not to contaminate the user with any hazardous substances. If garments are contaminated, then decontamination procedures should be followed prior to removal of the garment. The wearing of chemical protective clothing may cause head stress if appropriate consideration is not given to the workplace environment. Appropriate under garments should be considered to minimize head stress or damage your garment.

Do not use for:

Contact with heavy oils, sparks or flame, or combustible liquids; Environments with high mechanical risks (abrasions, tears, cuts); Environments with conditions of excessive heat.

Important Notice

This guide is only an outline. Before using any protective clothing or accessories, the wearer must read and understand the user information for each product. Specific country legislation should be observed. If in doubt, contact a safety professional. Selection of the most appropriate PPE and accessories will depend on the particular situation and should only be made by a competent person knowledgeable of the actual working conditions and the limitations of PPE and accessories. Final determination as to the suitability of these products for a particular situation is the employer's responsibility.

Central Address

Atatürk Mah. 31043 Sk. Kubat Apt.
No: 8/B Mezitli / MERSİN/TURKEY

Organized Industrial Zone Address

Çilek Mah. 63150 Sk. No:3 Akdeniz / MERSİN

Free Zone Mask Factory

Karaduvar Mah. Serbest Bölge 7. Cad. No: 21 33020 Mersin/TURKEY

Free Zone Textile Factory

Karaduvar mahallesi serbest bölge 18. cadde
dış kapı no:9 iç kapı no Z1 Akdeniz/MERSİN