



ENMED®-ENM - 422

Disposable CPE Shoe Cover

Lightweight, completely waterproof plastic shoe cover for light duty applications. Constructed of polyethylene (PE). Elastic band around ankle allows for a one-size-fits-most fit. Cleanroom validated/certified.

KEY FEATURES

- Completely waterproof
- Lightweight
- Lint-free

APPLICATIONS

- Laboratories
- Manufacturing
- Research & Development
- Food Processing
- Cleanrooms
- Autopsies/Medical Examinations

Materials

Material: Polypropylene fabric

Elastic: Neoprene Rubber

Seams: Heat sealed

Sizing - Universal

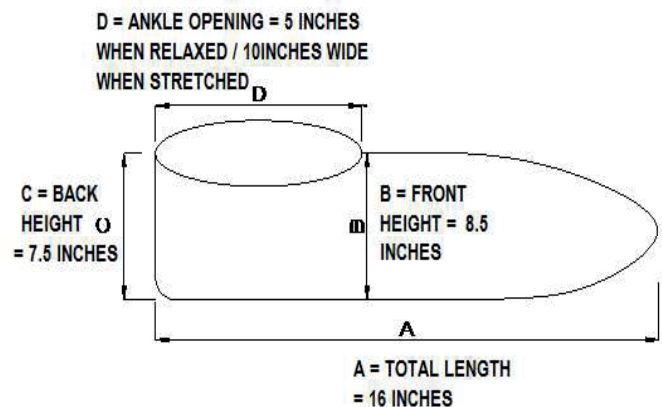







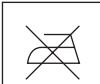

Storage and Disposal

- Store in dry, clean conditions in original packaging, away from direct sunlight, sources of high temperature, and solvent vapours
- Store within the temperature range -5°C to +25°C and with relative humidity below 80%
- Expected shelf life is three years from date of manufacture when stored as stated
- Replace garments if damaged, heavily contaminated or in accordance with local work practice or regulations
- Handle and dispose of contaminated garments with care and in accordance with applicable regulations

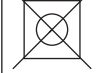

Limited Use

	DO NOT REUSE		DO NOT BLEACH		DO NOT IRON
	DO NOT DRY CLEAN		FLAMMABLE KEEP AWAY FROM SPARKS OF FLAMES		CONSULT INSTRUCTIONS FOR USE
	DO NOT WASH LAUNDRING IMPACTS UPON PROTECTIVE PERFORMANCE		DO NOT MACHINE DRY		CAUTION

Approvals

CE approved under PPE Directive (EU) 2016/425, Category III
Certification: Universal Sertifikasyon ve Gözetim Hiz. Tic. Ltd. Sti.
Notified Body Numder: 2163

Warnings and Limitations

Before use be sure that the product is suitable for the application and fitted correctly. Product must never be altered or modified.

Do not use for:

Contact with heavy oils, sparks or flame, or combustible liquids;
Environments with high mechanical risks (abrasions, tears, cuts)